

Caillebotis PE 1200*800

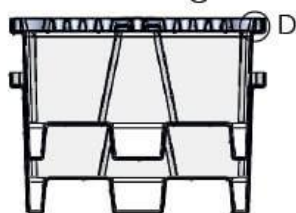

COUPE C-C

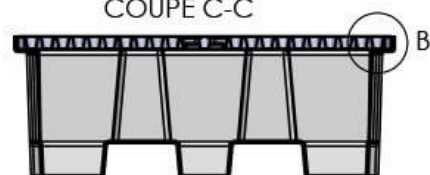

COUPE A-A

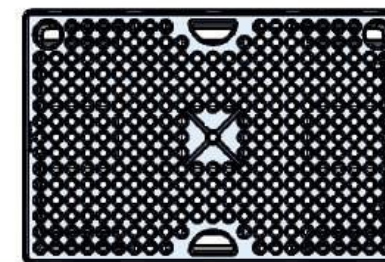
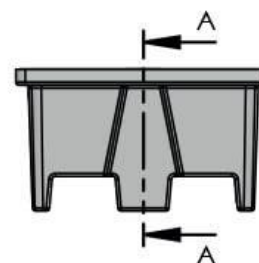

- Bac de rétention 240 L Jaune (2 fûts) avec caillebotis PEHD Noir
- Bac de rétention 100% PEHD avec Caillebotis amovible en PEHD
- Passage de fourches sur 4 cotés
- Encombrement optimisé pour mettre 3 bacs sous une lisse de 2700 mm

- Dim. hors tout (L x p x h) : 1212 x 812 x 450 mm
- Dim. Caillebotis (L x l) : 1200 x 800 mm
- Coloris : Jaune
- Capacité de rétention : 240 litres
- Capacité de charge (UR) : 650 kg



240L HDPE yellow retention tank - plastic duckboard

FR ■ 1 ENG ■ 2

Famille / Family : Drums retention tank

REFERENCE : 070651

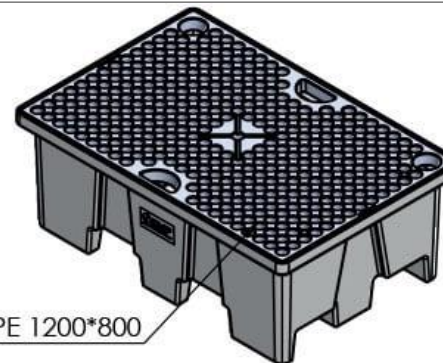
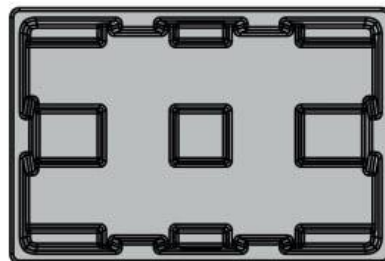
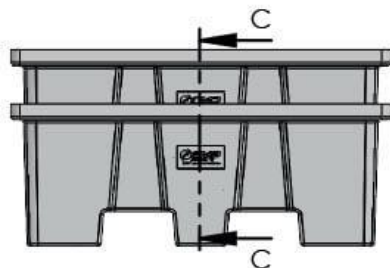

Caillebotis PE 1200*800

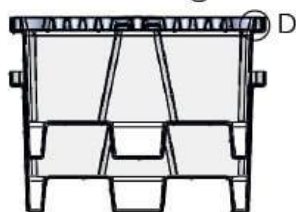

COUPE C-C

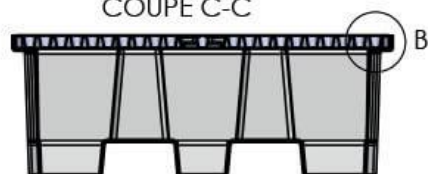

COUPE A-A

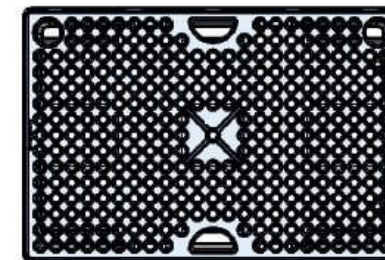
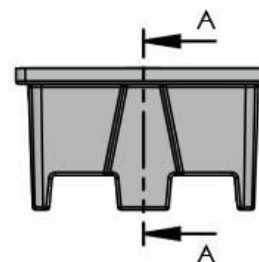

- 240 L yellow retention tank (2 drums) with black HDPE duckboard
- 100% HDPE with removable HDPE duckboard
- Forklift access on 4 sides
- Optimised dimensions to fit 3 tanks under a 2700 mm beam

- Overall dimensions (L x D x H): 1212 x 812 x 450 mm
- duckboard dimensions (L x W): 1200 x 800 mm
- Colour: Yellow
- Spill capacity: 240 litres
- Load capacity (UR): 650 kg

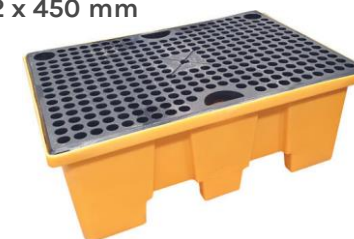

Réf. Doc : F11 - Créé le : 09/01/04 - Modifié le : 05/08/09 - indice : C